



POLY-CLASSIC®

CRF *Craftsman Series*

- MADE FROM EXPANDED CELLULAR PVC
- E-Z LOCK JOINT DESIGN
- ASSEMBLES AROUND A STRUCTURAL SUPPORT
- MIX-N-MATCH
- LOW MAINTENANCE
- LIMITED LIFETIME WARRANTY
- READY TO PRIME AND PAINT
- CUSTOM SIZES AVAILABLE

**THE STYLE IS TIMELESS.
NOW THE COLUMN IS, TOO.**

Born out of the understated, practical tradition of the early 1900s Arts and Crafts movement, the square tapered column has become popular in modern adaptations of the the Craftsman, Prairie, Bungalow, Country and Mission style homes of today. Now this timeless style is available in expanded cellular PVC for quick, easy assembly and virtually maintenance-free performance!

PRECISION MITER JOINTS

Vertical edges of Craftsman shafts (tapered, non-tapered, pedestal and newel post styles) all incorporate the E-Z Lock miter joint for consistently straight miters.



PLAN TYPES

Craftsman Series are available in the following plan types. Please specify when you order. (Customer may specify actual returns, wall thicknesses, etc.) Plan O & N are available only as non-tapered.

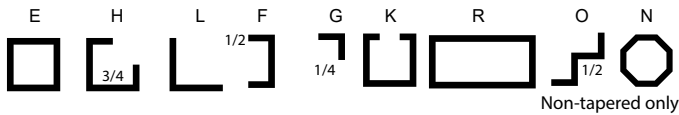

PANEL STYLES

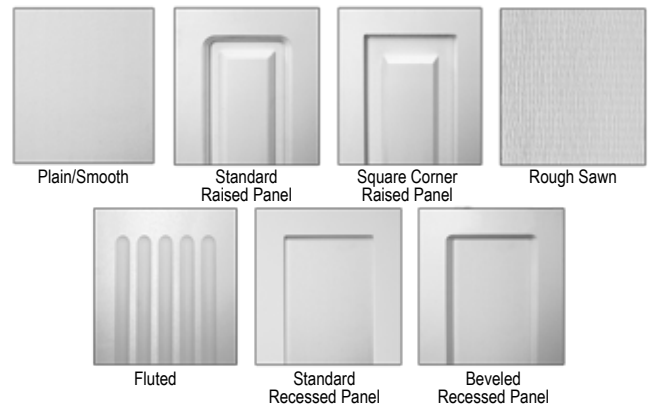

CRAFTSMAN PEDESTALS AND NEWELS



Craftsman Standard Tapered Square

Craftsman Standard Tapered Square with Raised Panels

Craftsman Standard Tapered Square with Recessed Panels

Craftsman Non-Tapered Square Smooth

Craftsman Non-Tapered Square Fluted

Craftsman Non-Tapered Square Raised Panels

Craftsman Non-Tapered Square Recessed Panels

POLY-CLASSIC® PVC CRAFTSMAN SERIES TAPERED COLUMN WRAPS

Craftsman columns are available plain, or with three different paneled options: raised panel, "square corner" raised panel, and recessed panel. (Since all tooling used for routing the panels is done with round bits, there will always be some radius in the corners. The "square corner" style uses the smallest bit possible to minimize that radius - about 1/16".)

Bottom Width* > Top Width* x Height (A)	Shaft dimensions				Panel dimensions †			
	Bottom		Top		From bottom of shaft ‡	From top of shaft	From side of shaft	Width of routed channel
	Outside width	Inside width	Outside width	Inside width				
	B	C	E	D	F	G	I	H
10" > 6" x 4'	9 5/8"	8 3/8"	5 5/8"	4 3/8"	10 1/2"	2 1/2"	1 1/4"	1/4"
10" > 6" x 5'								
10" > 6" x 6'								
10" > 6" x 8'								
10" > 6" x 9'								
10" > 6" x 10'								
12" > 6" x 4'	11 5/8"	10 3/8"	7 5/8"	6 3/8"	10 1/2"	2 1/2"	1 1/2"	1 1/4"
12" > 6" x 5'								
12" > 6" x 6'								
12" > 6" x 8'								
12" > 6" x 9'								
12" > 6" x 10'								
16" > 6" x 4'	15 5/8"	14 3/8"	11 5/8"	10 3/8"	10 1/2"	2 1/2"	1 1/2"	1 1/4"
16" > 6" x 5'								
16" > 6" x 6'								
16" > 6" x 8'								
16" > 6" x 9'								
16" > 6" x 10'								
20" > 6" x 4'	19 5/8"	18 3/8"	13 5/8"	12 3/8"	10 1/2"	2 1/2"	1 1/2"	1 1/4"
20" > 6" x 5'								
20" > 6" x 6'								
20" > 6" x 8'								
20" > 6" x 9'								
20" > 6" x 10'								
24" > 6" x 4'	23 5/8"	22 3/8"	15 5/8"	14 3/8"	10 1/2"	2 1/2"	1 1/2"	1 1/4"
24" > 6" x 5'								
24" > 6" x 6'								
24" > 6" x 8'								
24" > 6" x 9'								
24" > 6" x 10'								

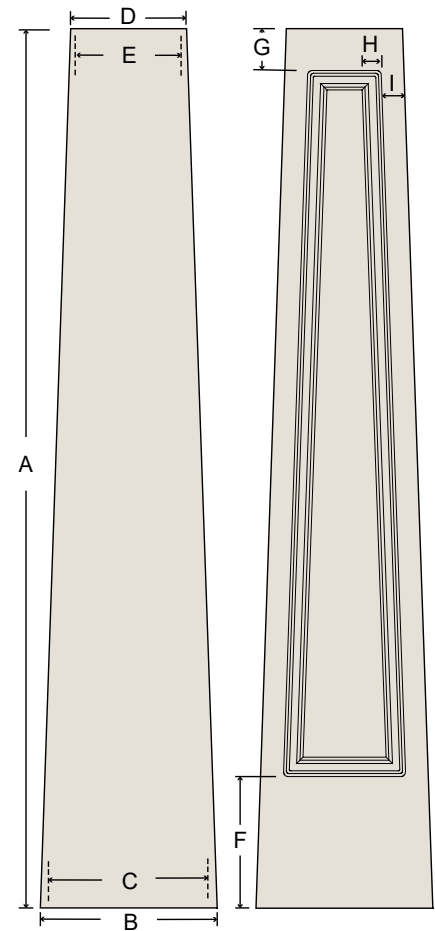

* Actual net width is 3/8" less than nominal (before trimming). Standard cap and base add 5" to the net width.
Corners on our "Square Corner" Raised Panel are as close to square as can be cut with the CNC router - approx 1/16" radius.

POLY-CLASSIC® PVC CRAFTSMAN SERIES TAPERED CAP AND BASE

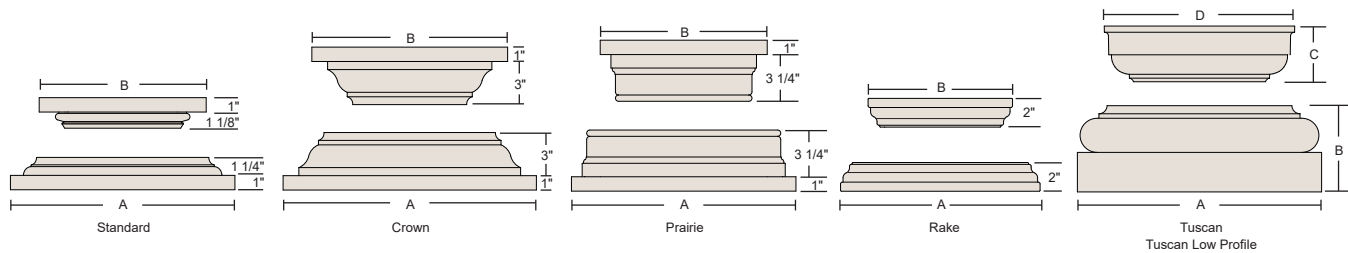

Column nominal bottom width	Standard		Crown		Prairie		Rake		Tuscan *				Tuscan Low Profile **			
	Base	Cap	Base	Cap	Base	Cap	Base	Cap	Base		Cap		Base		Cap	
	A	B	A	B	A	B	A	B	A	B	C	D	A	B	C	D
10"	13 5/8"	9 5/8"	15 5/8"	11 5/8"	13 5/8"	9 5/8"	12"	8"	13 1/2"	5 1/4"	9 1/2"	3 9/16"	n/a			
12"	15 5/8"	11 5/8"	17 5/8"	13 5/8"	15 5/8"	11 5/8"	14"	10"	17"	6"	13"	3 7/8"	n/a			
16"	19 5/8"	15 5/8"	21 5/8"	17 5/8"	19 5/8"	15 5/8"	18"	14"	19 1/2"	8 3/8"	18 3/8"	5 9/16"	20 5/8"	7 7/16"	17 3/4"	5"
20"	23 5/8"	17 5/8"	25 5/8"	19 5/8"	23 5/8"	17 5/8"	22"	16"	27"	10 3/4"	22 1/4"	6 1/2"	24 5/8"	7 7/16"	20 1/4"	5"
24"	27 5/8"	19 5/8"	29 5/8"	21 5/8"	27 5/8"	19 5/8"	26"	18"	32 1/2"	13 1/4"	26 1/4"	7 13/16"	28 5/8"	7 7/16"	22 3/8"	5"

* 10" and 12" cap/base are "L" shape mitered parts; 14" and larger are shipped in lineal parts, mitered to fit.

** This cap and base set uses the 14" Tuscan cap and base profile, for all widths, with standard necking. These are the style of Tuscan cap and base used on PVC prior to 2021, and are suitable for replacements to match those, as well as new projects.

POLY-CLASSIC® CRAFTSMAN NON-TAPERED SQUARE

Nominal Width	Shaft Dimensions		Panel and Flute Spacing †		Panels †		Flutes	
	Net Bottom Width	Inside Bottom Width	From bottom of Shaft ‡	From Top of Shaft	From Side of Shaft	Width of Routed Channel	Number of Flutes	Flute Width
	B	C	D	E	G	F		
6"	5 5/8"	4 3/8"	16 3/4"	8 1/2"	1 1/4"	3/4"	20	1/2"
8"	7 5/8"	6 3/8"	16 3/4"	8 1/2"	1 1/2"	1 1/4"	20	3/4"
10"	9 5/8"	8 3/8"	16 3/4"	8 1/2"	1 1/2"	1 1/4"	20	1"
12"	11 5/8"	10 3/8"	16 3/4"	8 1/2"	1 1/2"	1 1/4"	20	1 1/4"
14"	13 5/8"	12 3/8"	16 3/4"	9"	2"	1 1/4"	24	1 1/4"
16"	15 5/8"	14 3/8"	16 3/4"	9 1/4"	2 1/4"	1 1/4"	28	1 1/4"
18"	17 5/8"	16 3/8"	16 3/4"	9 1/2"	2 1/2"	1 1/4"	32	1 1/4"
20"	19 5/8"	18 3/8"	16 3/4"	9 3/4"	2 3/4"	1 1/4"	36	1 1/4"
22"	21 5/8"	20 3/8"	16 3/4"	10"	3"	1 1/4"	40	1 1/4"
24"	23 5/8"	22 3/8"	16 3/4"	10 1/4"	3 1/4"	1 1/4"	44	1 1/4"

† Dimensions except width also apply to recessed panel shafts.

‡ Dimension shown is for standard shafts. On custom height columns the panels/flutes start 4" from the top of the base selected, and dimension (G) from the cap (or optional neck moulding).

Nominal Column Width	Standard Sizes A							Nominal Column Width	Standard Sizes A								
	4'	5'	6'	8'	9'	10'	12'		8'	10'	12'	14'	16'	18'	20'	22'	24'
6"	✓	✓	✓	✓	✓	✓	✓	14"	✓	✓	✓	✓					
8"	✓	✓	✓	✓	✓	✓	✓	16"	✓	✓	✓	✓	✓				
10"	✓	✓	✓	✓	✓	✓	✓	18"	✓	✓	✓	✓	✓	✓			
12"	✓	✓	✓	✓	✓	✓	✓	20"	✓	✓	✓	✓	✓	✓	✓		
								22"	✓	✓	✓	✓	✓	✓	✓	✓	
								24"	✓	✓	✓	✓	✓	✓	✓	✓	✓

Custom widths and heights may be requested in any size up to 24' tall and 48" wide. Cap and base trim and platforms will be adjusted as needed for the revised shaft width.

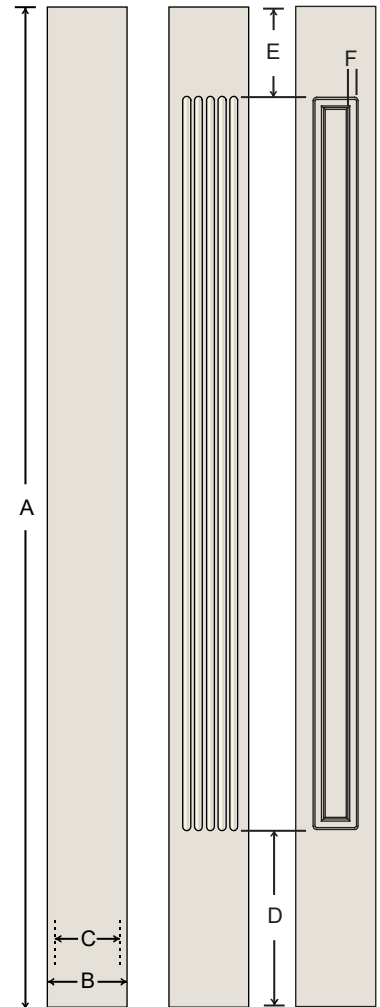

POLY-CLASSIC® PVC CRAFTSMAN SERIES NON-TAPERED CAP AND BASE

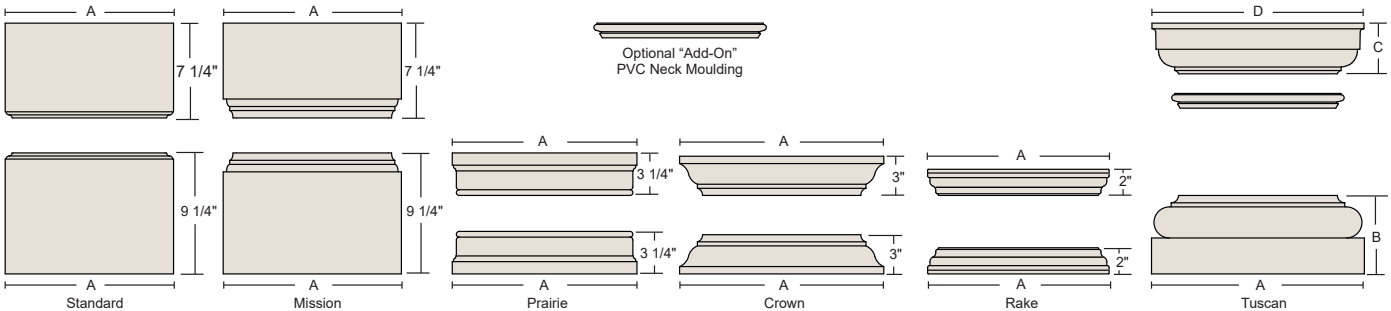

Column Width	Standard Width A	Mission Width A	Prairie Width A	Crown Width A	Rake Width A	Tuscan *				Tuscan Low Profile **			
						Base		Cap		Base		Cap	
						Width A	Height B	Width C	Height D	Width A	Height B	Width C	Height D
6"	6 7/8"	7 5/8"	8 1/8"	9 7/8"	8"	8"	3 7/32"	8 7/16"	2 1/2"	n/a			
8"	8 7/8"	9 5/8"	10 1/8"	11 7/8"	10"	11 3/8"	4 1/4"	11 1/4"	2 11/16"	n/a			
10"	10 7/8"	11 5/8"	12 1/8"	13 7/8"	12"	13 1/2"	5 1/4"	13 7/32"	3 9/16"	n/a			
12"	12 7/8"	13 5/8"	14 1/8"	15 7/8"	14"	17"	6"	17 1/4"	3 7/8"	n/a			
14"	14 7/8"	15 5/8"	16 1/8"	17 7/8"	16"	18 5/8"	7 7/16"	19"	5"	18 5/8"	7 7/16"	19"	5"
16"	16 7/8"	17 5/8"	18 1/8"	19 7/8"	18"	21 1/2"	8 3/8"	21 7/8"	5 9/16"	20 5/8"	7 7/16"	21"	5"
18"	18 7/8"	19 5/8"	20 1/8"	21 7/8"	20"	24 1/4"	9 5/8"	24 5/8"	6"	22 5/8"	7 7/16"	23"	5"
20"	20 7/8"	21 5/8"	22 1/8"	23 7/8"	22"	27"	10 3/4"	27 3/8"	6 1/2"	24 5/8"	7 7/16"	25"	5"
22"	22 7/8"	23 5/8"	24 1/8"	25 7/8"	24"	29 3/4"	12 1/8"	30 1/8"	7 3/16"	26 5/8"	7 7/16"	27"	5"
24"	24 7/8"	25 5/8"	26 1/8"	27 7/8"	26"	32 1/2"	13 1/4"	32 7/8"	7 13/16"	28 5/8"	7 7/16"	27"	5"

* 6" to 12" cap/base are "L" shape mitered parts; 14" and larger are shipped in lineal parts, mitered to fit.

** This cap and base set uses the 14" Tuscan cap and base profile, for all widths, with standard necking. These are the style of Tuscan cap and base used on PVC prior to 2021, and are suitable for replacements to match those, as well as new projects.

POLY-CLASSIC® PVC CRAFTSMAN SERIES ROUGH-SAWN COLUMNS

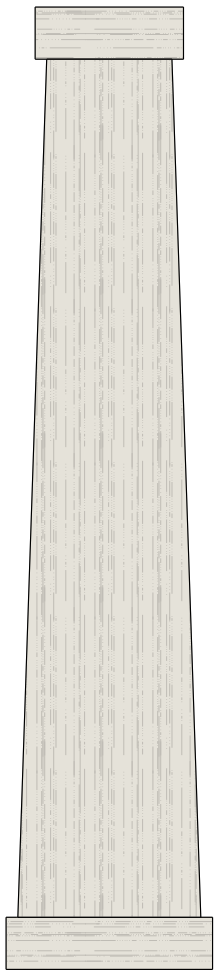

Bottom Width* > Top Width* > x Height (A)	Shaft dimensions			
	Bottom		Top	
	Outside width	Inside width	Outside width	Inside width
	B	C	E	D
10" > 6" x 4'	9 5/8"	8 3/8"	5 5/8"	4 3/8"
10" > 6" x 5'				
10" > 6" x 6'				
10" > 6" x 8'				
10" > 6" x 9'				
10" > 6" x 10'				
12" > 6" x 4'	11 5/8"	10 3/8"	7 5/8"	6 3/8"
12" > 6" x 5'				
12" > 6" x 6'				
12" > 6" x 8'				
12" > 6" x 9'				
12" > 6" x 10'				



The Craftsman Series Rough-Sawn columns come in tapered and non-tapered styles.

- * Limited Lifetime Warranty
- * Shipped KD (knockdown) and palletized.
- * E-Z Lock joints for easy installation.
- * Precision milled expanded cellular PVC
- * Low maintenance, rot proof, water proof, insect proof

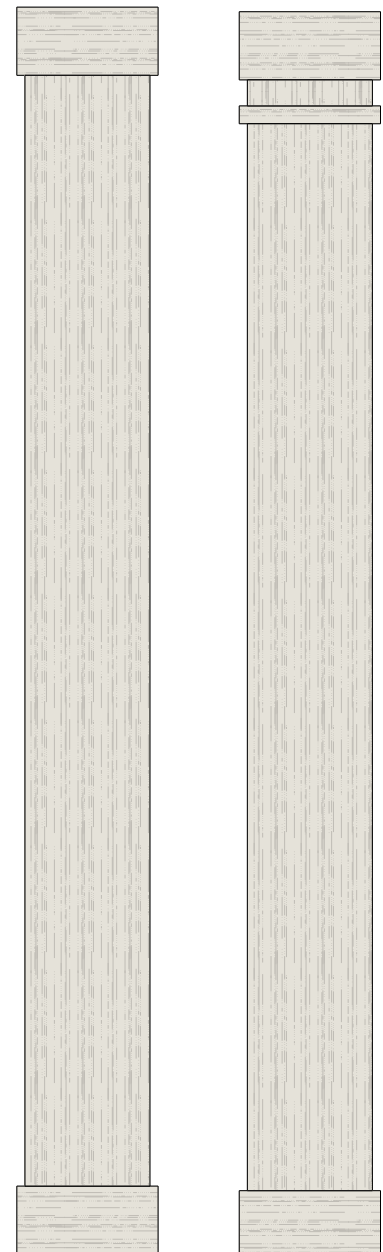

TAPERED CAP AND BASE



Column Width	Width	Height
10"	10 7/8"	3 1/4"
12"	12 7/8"	3 1/4"

NON-TAPERED CAP AND BASE



Column Width	Width	Height
6"	6 7/8"	5 1/4"
8"	8 7/8"	5 1/4"
10"	10 7/8"	5 1/4"
12"	12 7/8"	5 1/4"

Nominal Width* x Height	Shaft dimensions	
	Bottom	
	Outside width	Inside width
	B	C
6" x 4'	5 5/8"	4 3/8"
6" x 5'		
6" x 6'		
6" x 8'		
6" x 9'		
6" x 10'		
6" x 12'	7 5/8"	6 3/8"
8" x 4'		
8" x 5'		
8" x 6'		
8" x 8'		
8" x 9'		
8" x 10'	9 5/8"	8 3/8"
8" x 12'		
10" x 4'		
10" x 5'		
10" x 6'		
10" x 8'		
10" x 9'	11 5/8"	10 3/8"
10" x 10'		
10" x 12'		
12" x 4'		
12" x 5'		
12" x 6'		
12" x 8'		
12" x 9'		
12" x 10'		
12" x 12'		

* Actual net width is 3/8" less than nominal. Standard cap and base add 1-1/4" to the net width.

POLY-CLASSIC® CRAFTSMAN PEDESTALS AND NEWELS



Standard Pedestal



Prairie Pedestal Recessed Panel



Prairie Pedestal Raised Panel

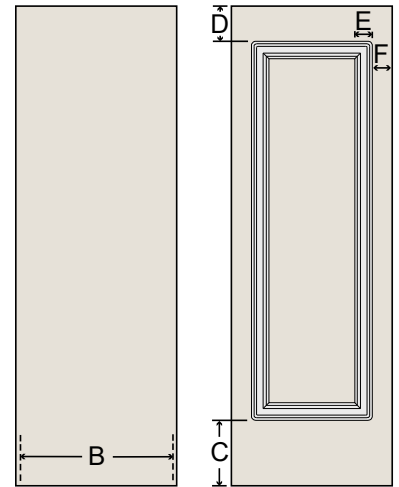

Nominal Width	Shaft Widths		Panels (Standard Trim)		Panels (Prairie Trim)		Panels		Available Heights						
	Outside B	Inside C	From Bottom of Shaft D	From Top of Shaft E	From Bottom of Shaft D	From Top of Shaft E	Width of Router Channel F	From Side of Shaft G	32"	36"	40"	44"	48"	54"	60"
									✓	✓	✓	✓	✓	✓	✓
6"	5 5/8"	4 3/8"	4 3/4"	3 3/4"	4 3/4"	2 5/8"	7/8"	1 1/4"	✓	✓	✓	✓	✓	✓	✓
8"	7 5/8"	6 3/8"	4 3/4"	3 3/4"	4 3/4"	2 5/8"	1 1/4"	1 1/2"	✓	✓	✓	✓	✓	✓	✓
10"	9 5/8"	8 3/8"	4 3/4"	3 3/4"	4 3/4"	2 5/8"	1 1/4"	1 1/2"	✓	✓	✓	✓	✓	✓	✓
12"	11 5/8"	10 3/8"	4 3/4"	3 3/4"	4 3/4"	2 5/8"	1 1/4"	1 1/2"	✓	✓	✓	✓	✓	✓	✓
14"	13 5/8"	12 3/8"	5 1/4"	4 1/4"	5 1/4"	3 1/8"	1 1/4"	2"	✓	✓	✓	✓	✓	✓	✓
16"	15 5/8"	14 3/8"	5 1/2"	4 1/2"	5 1/2"	3 3/8"	1 1/4"	2 1/4"	✓	✓	✓	✓	✓	✓	✓
18"	17 5/8"	16 3/8"	5 3/4"	4 3/4"	5 3/4"	3 5/8"	1 1/4"	2 1/2"	✓	✓	✓	✓	✓	✓	✓
20"	19 5/8"	18 3/8"	6"	5"	6"	3 7/8"	1 1/4"	2 3/4"	✓	✓	✓	✓	✓	✓	✓
22"	21 5/8"	20 3/8"	6 1/4"	5 1/4"	6 1/4"	4 1/8"	1 1/4"	3"	✓	✓	✓	✓	✓	✓	✓
24"	23 5/8"	22 3/8"	6 1/2"	5 1/2"	6 1/2"	4 3/8"	1 1/4"	3 1/4"	✓	✓	✓	✓	✓	✓	✓
26"	25 5/8"	24 3/8"	6 3/4"	5 3/4"	6 3/4"	4 5/8"	1 1/4"	3 1/2"	✓	✓	✓	✓	✓	✓	✓
28"	27 5/8"	26 3/8"	7"	6"	7"	4 7/8"	1 1/4"	3 3/4"	✓	✓	✓	✓	✓	✓	✓
30"	29 5/8"	28 3/8"	7 1/4"	6 1/4"	7 1/4"	5 1/8"	1 1/4"	4"	✓	✓	✓	✓	✓	✓	✓

* Typically, pedestals are 4" wider than the column it is supporting, or about the same width as the base of the column which it supports.

POLY-CLASSIC® CRAFTSMAN PEDESTALS AND NEWEL CAPS AND BASES

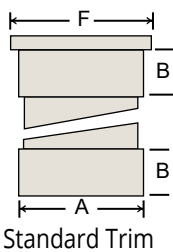

Standard Trim

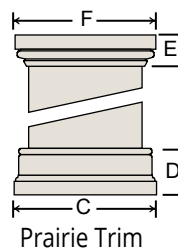

Prairie Trim

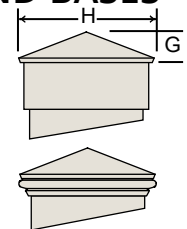

Pyramid Cap

Column Nominal Width	Standard Trim		Prairie Trim				Pyramid Cap	
	Width (A)	Height (B)	Width (C)	Height (D)	Top Height (E)	Top Width † (F)	Height ± 1/16" (G)	Width (H)
6"	6 7/8"	3 1/4"	8 1/8"	3 1/4"	2 1/8"	7 5/8"	2 1/16"	7 7/8"
8"	8 7/8"	3 1/4"	10 1/8"	3 1/4"	2 1/8"	9 5/8"	2 1/2"	9 7/8"
10"	10 7/8"	3 1/4"	12 1/8"	3 1/4"	2 1/8"	11 5/8"	2 7/8"	11 7/8"
12"	12 7/8"	3 1/4"	14 1/8"	3 1/4"	2 1/8"	13 5/8"	3 1/4"	13 7/8"
14"	14 7/8"	3 1/4"	16 1/8"	3 1/4"	2 1/8"	15 5/8"	3 5/8"	15 7/8"
16"	16 7/8"	3 1/4"	18 1/8"	3 1/4"	2 1/8"	17 3/8"	4"	17 7/8"
18"	18 7/8"	3 1/4"	20 1/8"	3 1/4"	2 1/8"	19 5/8"	4 3/8"	19 7/8"
20"	20 7/8"	3 1/4"	22 1/8"	3 1/4"	2 1/8"	21 5/8"	4 13/16"	21 7/8"
22"	22 7/8"	3 1/4"	24 1/8"	3 1/4"	2 1/8"	23 5/8"	5 3/16"	23 7/8"
24"	24 7/8"	3 1/4"	26 1/8"	3 1/4"	2 1/8"	25 5/8"	5 9/16"	25 7/8"
26"	26 7/8"	3 1/4"	28 1/8"	3 1/4"	2 1/8"	27 5/8"	6 5/16"	27 7/8"
28"	28 7/8"	3 1/4"	30 1/8"	3 1/4"	2 1/8"	29 5/8"	6 3/8"	29 7/8"
30"	30 7/8"	3 1/4"	32 1/8"	3 1/4"	2 1/8"	31 5/8"	6 3/4"	31 7/8"

POLY-CLASSIC® CRAFTSMAN ORNAMENTAL CAPITALS

Designed with crisp, true architectural detail, Ornamental Capitals artfully capture natural themes and images. Capitals for square Non-tapered Poly-Classic® Craftsman columns are crafted from poly/resin, and will ship split in half (to reassemble around the load support). Each style is proportionally scaled for the width of the shaft. The Empire with Necking, Greek

Erectheum with Necking, Modern Composite, Roman Corinthian, Roman Doric Ornamental, and Temple of Winds capitals will fit more accurately when the optional neck moulding is included. Since the shafts will be manufactured to be correct with the selected capital, there is no need to worry about a height adjustment value with PVC columns. Larger sizes may be available.



Empire



Empire with Necking



Greek Angular Ionic



Greek Erectheum



Greek Erectheum with Necking



Modern Composite



Roman Corinthian



Roman Doric Ornamental



Roman Ionic



Scamozzi



Temple of Winds

Shaft nominal bottom diameter	Empire			Empire with necking			Greek Angular Ionic			Greek Erectheum			Greek Erectheum with necking			Modern Composite		
	Capital height	Abacus width	Scroll width	Capital height	Abacus width	Scroll width	Capital height	Abacus width	Scroll width	Capital height	Abacus width	Scroll width	Capital height	Abacus width	Scroll width	Capital height	Abacus width	Scroll width
6"	3 3/4"	10"	9"	7 3/4"	10"	9"	n/a			3 3/4"	7 3/4"	11 3/4"	5 3/4"	7 3/4"	11 3/4"	8 1/2"	10 3/4"	n/a
8"	5 1/4"	13 1/2"	12 1/4"	10"	13 1/2"	12 1/4"	5 1/8"	14 1/4"	13 3/4"	5 1/4"	10 1/2"	15"	7 1/2"	10 1/2"	15"	11 1/2"	16 1/2"	n/a
10"	6 1/4"	18"	17"	11"	18"	17"	6"	17 1/4"	17"	6 1/4"	14 1/2"	21"	9 1/2"	14 1/2"	21"	14 1/2"	19"	n/a
12"	7 1/4"	20 1/4"	19 1/2"	14 1/2"	20 1/2"	19 1/2"	7 1/4"	20 3/4"	19 1/4"	6 3/4"	15"	20 1/2"	11 1/4"	15"	21"	17"	20"	n/a
14"	8 3/4"	23"	19 1/2"	17"	23"	19 1/2"	8 3/8"	20 1/2"	19 1/2"	9"	17 1/2"	26"	13 1/2"	17 1/2"	26"	n/a		
16"	10"	32"	26 1/4"	n/a			9 3/4"	24 1/4"	19 3/4"	10"	22 1/2"	29"	15"	22 1/2"	29"	22 1/2"	25"	n/a
18"	11 1/4"	34"	28"	n/a			n/a			11"	26"	36"	17"	26"	36"	n/a		
20"	12 3/4"	35 1/2"	35"	19"	35 1/2"	35"	12 3/4"	35"	34 1/2"	13"	30 1/2"	43"	19"	30 1/2"	43"	n/a		

Shaft nominal bottom diameter	Roman Corinthian			Roman Doric Ornamental			Roman Ionic			Scamozzi			Temple of Winds		
	Capital height	Abacus width	Scroll width	Capital height	Abacus width	Scroll width	Capital height	Abacus width	Scroll width	Capital height	Abacus width	Scroll width	Capital height	Abacus width	Scroll width
6"	8 1/2"	12"	n/a	4 1/2"	10 1/2"	n/a	3"	8 1/4"	10 1/2"	2 7/8"	10"	8"	7 1/2"	10 1/2"	n/a
8"	12"	15"	n/a	6"	14 1/4"	n/a	3 5/8"	10 1/2"	13 1/2"	3 1/2"	11"	9 3/8"	10"	13 7/8"	n/a
10"	14 1/2"	18 1/2"	n/a	7"	16 1/4"	n/a	4 1/2"	12 1/2"	16 1/2"	4 7/8"	16 3/4"	14"	11 5/8"	16 7/8"	n/a
12"	17"	22"	n/a	9"	21"	n/a	5 1/2"	17 1/2"	23"	5 1/2"	19"	16 3/4"	16"	19"	n/a
14"	20"	27"	n/a	10 1/2"	24"	n/a	6 1/8"	17 1/2"	22"	6 1/4"	22 1/4"	18 1/2"	16"	23"	n/a
16"	23"	32 1/2"	n/a	12 1/2"	28"	n/a	6 1/2"	20"	24 1/4"	7 1/2"	25"	20 1/4"	18 1/8"	26 3/4"	n/a
18"	25 1/2"	39"	n/a	n/a			8 3/4"	25"	31 3/4"	8 3/4"	26"	21 1/2"	21 1/2"	28"	n/a
20"	28 1/2"	42"	n/a	n/a			9"	25 1/4"	33"	10 1/4"	34 1/4"	29 1/2"	23 1/4"	34 1/2"	n/a

MIX-N-MATCH

CRAFTSMAN SERIES PEDESTALS WITH POLY-CLASSIC® FRP COLUMNS

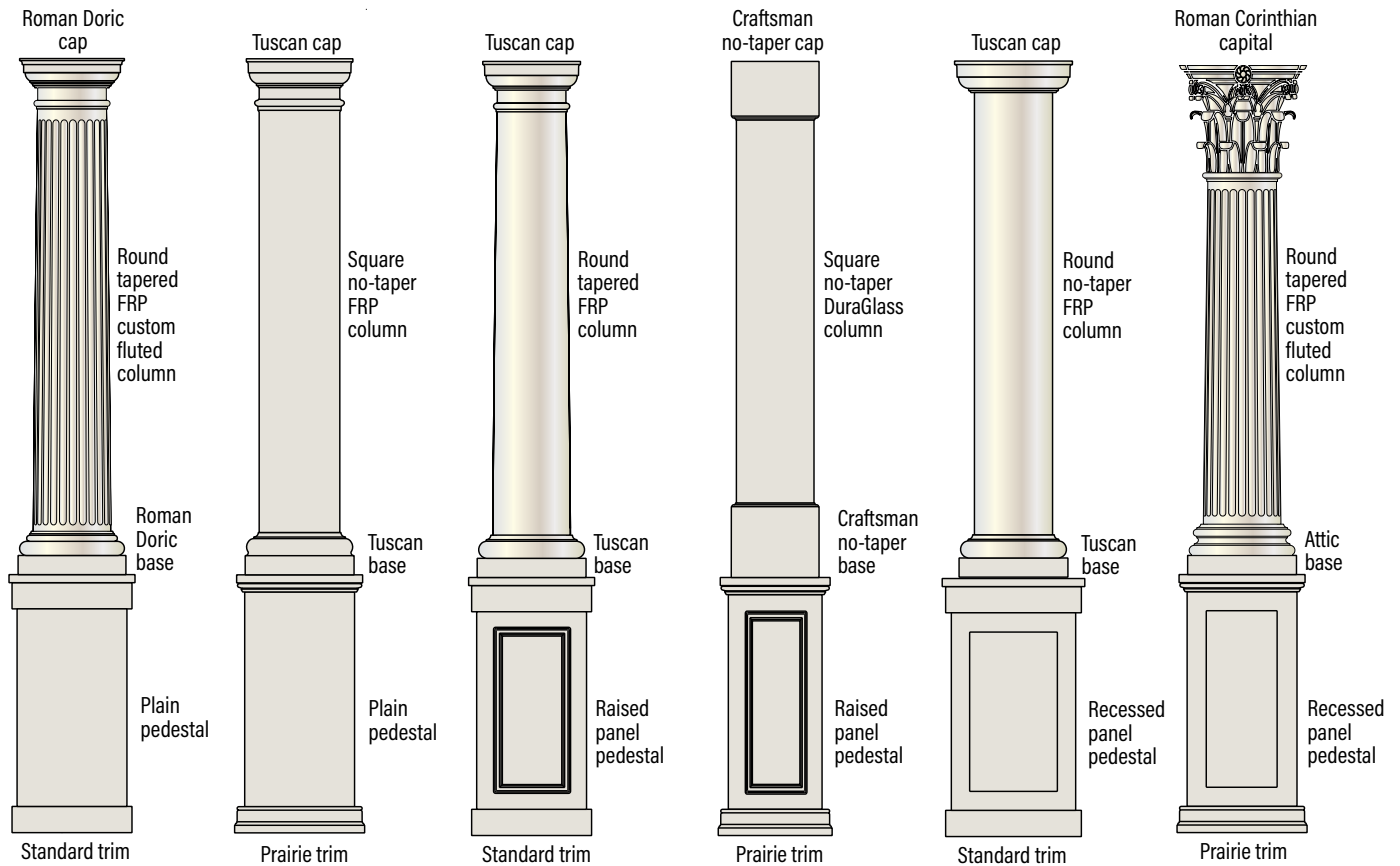

MIX-N-MATCH

CRAFTSMAN SERIES COLUMNS WITH CRAFTSMAN SERIES PEDESTALS

